

# DS/DA Series

## Serial/Parallel/RS485 communication input type Display Unit

NEW

### ■ Features

- Innovates existing display units and enables to wiring and replacement without soldering as Multi-stage connection
- Multi-stage connection by connector or connector cable to shorten wiring time
- Supports 7 types of basic input units  
: Serial input, Dynamic parallel input, RS485 com.(Modbus) input, Temp./Humi. sensor module input, Temp./Humi. sensor module input+RS485 com. output, Pt temp. sensor input, Pt temp. sensor input+RS485 com. output
- Expandable multi-stage up to 24 digits
- Several sizes for 16, 22.5, 40, 60mm
- Various displays with 7/16 segment, and using red/green mixed
- Adapts high luminance LED
- Enables to display several units (changing unit name plates) and control turning ON and flashing by unit-display unit
- Displays 64 characters and signs  
(0 to 9, A to Z, 27 signs, decimal point)



**⚠ Please read "Caution for your safety" in operation manual before using.**



### ■ Ordering information

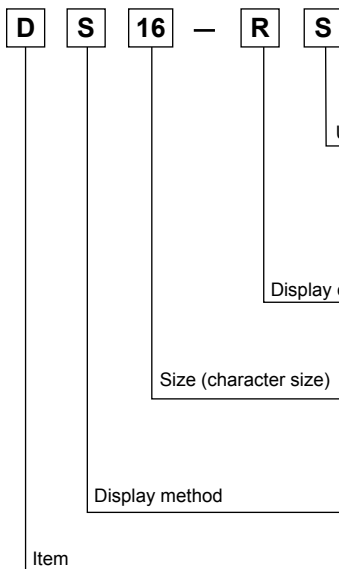

S		Serial input
P		Parallel input
T		RS485 communication input
D <sup>※2</sup>	Basic unit	Temp./Humi. sensor module input
DT <sup>※2</sup>		Temp./Humi. sensor module input+RS485 com. output
R <sup>※2</sup>		Pt temp. sensor input
DR <sup>※2</sup>		Pt temp. sensor input+RS485 com. output
E		Expansion unit
No-mark		Unit-display unit
R		Red
G		Green
16 <sup>※1</sup>		W16×H24mm (W9.0×H16.0mm)
22		W20×H33mm (W11.2×H22.5mm)
40		W40×H60mm (W22.4×H40.0mm)
60		W60×H96mm (W33.6×H60.0mm)
S		7 Segment
A		16 Segment
U <sup>※3</sup>		Unit-display unit
D		Display unit

※1: The '16' size model does not have the parallel input model and does not support 16 Segment display method.

※2: Temp./Humi. module input, Temp./Humi. module input + RS485 com. output, Pt sensor input, Pt sensor input+RS485 com. output models will be available.

※3: Unit-display unit has only 16, 22 size.

※4: Temp./Humi. sensor module input, Temp./Humi. sensor module input+RS485 com. output, Pt temp. sensor input, Pt temp. sensor input+RS485 com. output models support only red display color.

# Intelligent Display Unit

## ■ Specifications

Model	Basic unit	DS16-□S/T/D	D□22-□S/P/T/D/R	D□40-□S/P/T/D/DT/R/RT	D□60-□S/P/T/D/DT/R/RT	
	Expansion unit	DS16-□E	D□22-□E	D□40-□E	D□60-□E	
Input method		D□□-□S: Serial				
		D□□-□P: Parallel(Dynamic Parallel 1, Dynamic Parallel 2)				
		D□□-□T: RS485 communication(Modbus protocol)				
		DS□-RD/RDT: Temp./Humi. sensor module(THD-RM-S) input( <sup>†</sup> °C input type)				
		DS□-RR/RRT: Pt temp. sensor input(supports DPT100Q, JPt 100Q) <sup>※1</sup>				
Display color <sup>※2</sup>		Red, Green(selectable by model)				
Power supply		12-24VDC				
Allowable voltage range		90 to 110% of rated voltage				
Current consumption	Red	D□□-RS/RP/RT/RE	Max. 20mA	Max. 25mA	Max. 55mA	Max. 65mA
		D□□-RD/RDT/RR/RRT	Max. 40mA	Max. 40mA	Max. 55mA	Max. 65mA
	Green		Max. 15mA	Max. 20mA	Max. 40mA	Max. 45mA
Character size		W9×H16mm	W11.2×H22.5mm	W22.4×H40mm	W33.6×H60mm	
Max. Clock <sup>※3, ※4</sup>		<ul style="list-style-type: none"> <li>Serial input: Max. 2kHz</li> <li>Parallel input: Dynamic Parallel 1: Max. 3kHz, Dynamic Parallel 2: Max. 1.5kHz</li> </ul>				
Input logic <sup>※3</sup>		Selectable positive logic(PNP), negative logic(NPN)(change by the function set switch)				
Input resistance <sup>※3</sup>		20kΩ				
Input level <sup>※3</sup>		High: 4.5-24VDC, Low: 0-1.2VDC				
Display character <sup>※5</sup>		64 characters and signs(0 to 9, A to Z, 27 signs, decimal point)				
Display temp./humi. range		DS□-RD/RDT temperature: -19.9 to 60.0°C, humidity: 00.0 to 99.9%RH				
		DS□-RR/RRT temperature: -50.0 to 400.0°C or -58.0 to 752.0°F				
Display accuracy		DS□-RD/RDT temperature: ±1.0°C(room temperature <sup>※6</sup> ), humidity: ±2.0%RH(10 to 90%RH, room temperature <sup>※6</sup> )				
		DS□-RR/RRT: ±0.5% F.S.				
Output		—		RS485 com. output(Modbus RTU) <sup>※7</sup>		
The number of max. multi-stage connections		Serial/RS485 com. input: 24 units				
		Parallel: Dynamic Parallel 1 : 6 units(4Bit), 4 units(6Bit)/ Dynamic Parallel 2 : 24 units(6Bit)				
		Temp./Humi. sensor module input(+RS485 com. output): 6 units(3 units for temp. display, 3 units for humidity display, except unit-display unit)				
		Pt temperature sensor input(+RS485 com. output): 4EA(except unit-display unit)				
Noise resistance		±500V the square wave noise (pusel width: 1μs) by the noise simulator				
Environment	Ambient temperature	-10 to 55°C, storage: -25 to 65°C (for THD-RM-S, -19.9 to 60°C, storage: -19.9 to 60°C)				
	Ambient humidity	35 to 85%RH (for THD-RM-S, 0 to 99.9%, storage: 0 to 99.9%)				
Accessory	Basic unit	Cap: right/left 1EA	Cap: right/left 1EA, Connector : 1EA	Connector: 1EA <sup>※8</sup>		
	Expansion unit	—		Ribbon cable: 1EA(50mm)		
	DS□-RD/RDT	Temp./Humi. sensor module(THD-RM-S)				
Protection		IP40 (front part)				
Approval <sup>※5</sup>		CE				
Weight <sup>※9</sup>	D□□-□S/P/T/R/RT	Approx. 53g (approx. 12g)	Approx. 58g (approx. 17g)	Approx. 70g (approx. 28g)	Approx. 115g (approx. 60g)	
	DS□-RD/RDT	Approx. 168g (approx. 12g)	Approx. 173g (approx. 17g)	Approx. 184g (approx. 28g)	Approx. 216g (approx. 60g)	
	D□□-□E	Approx. 77g (approx. 12g) <sup>※10</sup>	Approx. 92g (approx. 17g) <sup>※10</sup>	Approx. 70g (approx. 28g)	Approx. 115g (approx. 60g)	

※1: 16 size model does not support Pt temperature sensor input.

※2: Temp./Humi. sensor module input, Temp./Humi. sensor module input+RS485 com. output, Pt temp. sensor input, Pt temp. sensor input+RS485 com. output models support only red display color.

※3: It is only for Serial, Parallel input models.

※4: Max. Clock is for 1:1 of duty ratio (ON, OFF ratio).

※5: It is only for Serial, Parallel, RS485 com. input models.

※6: Room temperature 23°C±5°C

※7: RS485 com. output supports only DS40-R□T, DS60-R□T models.

※8: It is only for Parallel input model.

※9: The weight is with packaging and the weight in parentheses is only unit weight.

※10: This is 3 units' weight as packaging unit and the weight in parentheses is only unit weight.

※Environment resistance is rated at no freezing or condensation.

(A) Photo electric sensor

(B) Fiber optic sensor

(C) Door/Area sensor

(D) Proximity sensor

(E) Pressure sensor

(F) Rotary encoder

(G) Connector/Socket

(H) Temp. controller

(I) SSR/Power controller

(J) Counter

(K) Timer

(L) Panel meter

(M) Tacho/Speed/Pulse meter

(N) Display unit

(O) Sensor controller

(P) Switching mode power supply

(Q) Stepper motor& Driver&Controller

(R) Graphic/Logic panel

(S) Field network device

(T) Software

(U) Other

# DS/DA Series

## Remove of protection cover

To operate the function set switch of the D□40, D□60 models, you should remove the protection cover.  
Press the connection parts (4 points) of the protection cover at the top/bottom of the product with a flat-head screwdriver and the protection cover is removed.

⚠Caution: Before removing the protection cover, power must be turned OFF.

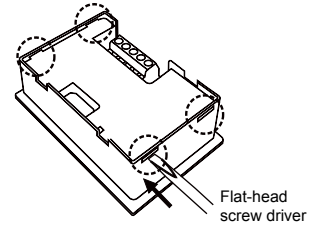

## Connection of units

### DS16/D□22

- Connect a basic unit, expansion units, a unit-display unit from the left and connect the caps the end of right and left.
- The middle bracket (sold separately) helps to protect deflection when connecting over 7 units. Use one middle bracket per 7 units.
- The basic unit supplies the power for expansion units and the unit-display unit and DATA input.

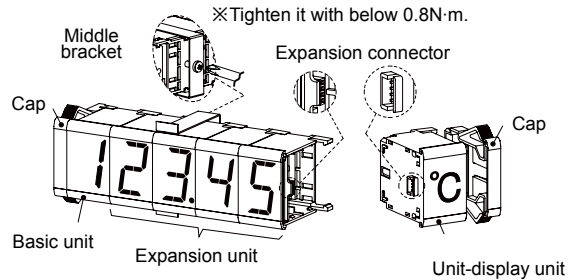

### D□40/D□60

Connect expansion connectors of units using a ribbon cable (accessory) as (Figure 1).  
If the distance between expansion units is far as (Figure 2), you can connect the cable at the soldering pad.  
To use a soldering pad, remove the protection cover which only expansion units have.

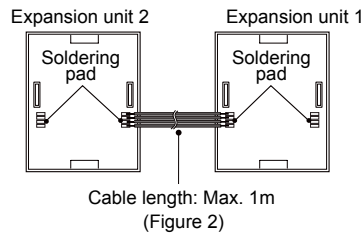
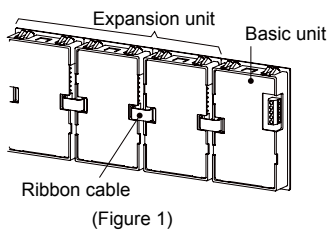

※You can use both the 7 segment display method model and the 16 segment display method model mixed.

## Input circuit

### Positive logic(PNP) input

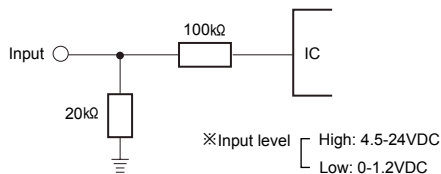

### Negative logic(NPN) input

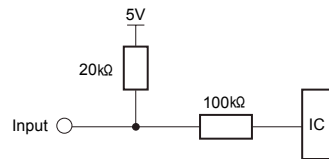

## Connections

### Temp./Humi. sensor module input model

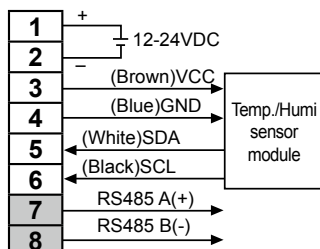

### Pt temp. sensor input model

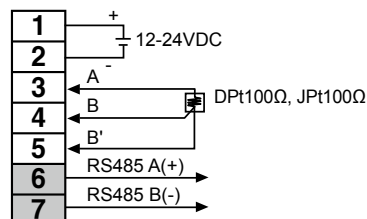

※Shaded terminals are only for the model supporting RS485 communication output(DS40-R□T, DS60-R□T).

## Part descriptions and function setting

Only the basic unit model has the function set switch and the input terminal.  
The DS16, D□22 models have them at the side, and the D□40, D□60 models have them at the rear.

### Serial input model

#### ① Expansion connector

Using for connecting units.  
Refer to 'Connection of units'.

#### • DS16-□S

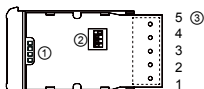

#### • D□22-□S

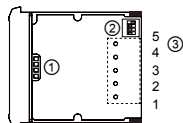

#### • D□40-□S

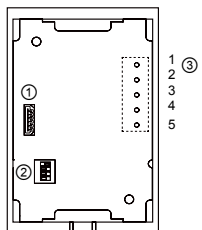

#### • D□60-□S

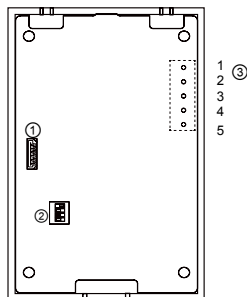

#### ② Function set switch

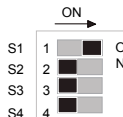

<Factory default>

No.	Switch		Function
	OFF	ON	
S1	Positive logic (PNP)	Negative logic (NPN)	Input logic
S2	Not used	Used	Zero Blanking
S3	Not used	Used	Decimal number display <sup>※1</sup>
S4	8Bit	5Bit <sup>※2</sup>	Data input Bit

※1: The other data except 0 to 9 are blank.

※2: 5 Bit data input is compatible with Autonics pulse meter (MP5W) and panel meter (MT4Y, MT4W).

#### ③ Input terminals

No.	Code	Function
1	VCC	12-24VDC
2	GND	0V
3	Data	Data input
4	CLOCK	CLOCK input
5	LATCH	LATCH input

※For the D□22-□S, connect the connector to input terminal.

### Parallel input model

#### ① Expansion connector

Using for connecting units.  
Refer to 'Connection of units'.

#### • D□22-□P

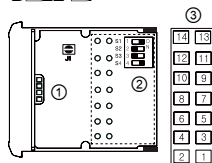

#### • D□40-□P

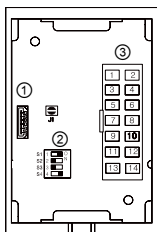

#### • D□60-□P

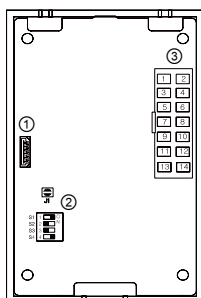

#### ② Function set switch

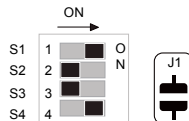

<Factory default>

No.	Switch		Function
	OFF	ON	
S1	Positive logic (PNP)	Negative logic (NPN)	Input logic
S2	Not used	Used	Zero Blanking
S3	6Bit	4Bit <sup>※2</sup>	Data input Bit
S4	Dynamic 1	Dynamic 2	Dynamic 1/2 selection
J1			All Zero Blanking <sup>※1</sup>

※1: 4 Bit Data input is compatible with Autonics pulse meter (MP5Y, MP5W, panel meter (MT4Y, MT4W).

※2: When every number is '0', it becomes All Zero Blanking.

Ex) When displaying 000045 using two basic units, Using All Zero Blanking,



Not using All Zero Blanking



(A) Photo electric sensor

(B) Fiber optic sensor

(C) Door/Area sensor

(D) Proximity sensor

(E) Pressure sensor

(F) Rotary encoder

(G) Connector/Socket

(H) Temp. controller

(I) SSR/Power controller

(J) Counter

(K) Timer

(L) Panel meter

(M) Tacho/Speed/Pulse meter

(N) Display unit

(O) Sensor controller

(P) Switching mode power supply

(Q) Stepper motor & Driver & Controller

(R) Graphic/Logic panel

(S) Field network device

(T) Software

(U) Other

# DS/DA Series

## ③ Input terminals

No.	Dytamic Parallel 1				Dytamic Parallel 2 <sup>*1</sup>	
	4Bit Data input		6Bit Data input		6Bit Data input	
	Code	Function	Code	Function	Code	Function
1	VCC	12-24VDC	VCC	12-24VDC	VCC	12-24VDC
2	GND	0V	GND	0V	GND	0V
3	LE5	LATCH 5	LE3	LATCH 3	LATCH	LATCH input
4	LE4	LATCH 4	LE2	LATCH 2	CLOCK	CLOCK input
5	LE3	LATCH 3	LE1	LATCH 1	—	—
6	LE2	LATCH 2	LE0	LATCH 0	UNIT	Unit
7	LE1	LATCH 1	DP	Decimal point	DP	Decimal point
8	LE0	LATCH 0	D5	2 <sup>5</sup> Data	D5	2 <sup>5</sup> Data
9	DP	Decimal point	D4	2 <sup>4</sup> Data	D4	2 <sup>4</sup> Data
10	D3	2 <sup>3</sup> Data	D3	2 <sup>3</sup> Data	D3	2 <sup>3</sup> Data
11	D2	2 <sup>2</sup> Data	D2	2 <sup>2</sup> Data	D2	2 <sup>2</sup> Data
12	D1	2 <sup>1</sup> Data	D1	2 <sup>1</sup> Data	D1	2 <sup>1</sup> Data
13	D0	2 <sup>0</sup> Data	D0	2 <sup>0</sup> Data	D0	2 <sup>0</sup> Data
14	GND	0V	GND	0V	GND	0V

※1: When selecting Dynamic Parallel 2, 6 Bit Data input, All Zero Blanking OFF are fixed.

## ◎ RS485 communication input model

### ① Expansion connector

Using for connecting units.  
Refer to '■ Connection of units'.

#### ● DS16-□T

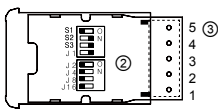

#### ● D□22-□T

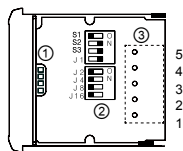

#### ● DS40/DA40-□T

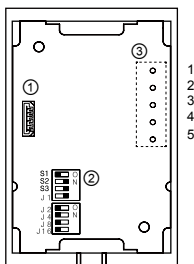

#### ● DS60/DA60-□T

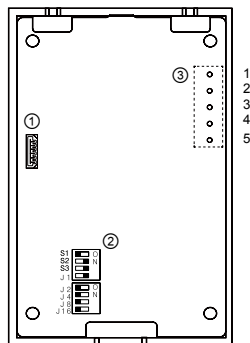

### ② Function set switch

Using for setting communication response time, communication speed, and communication address

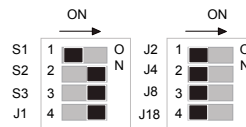

<Factory default>

No.	Switch	Function
S1	OFF : 5ms, ON : 20ms	Communication response time
S2	4800	Communication speed (bps) selection (OFF : 0, ON : 1)
S3	9600 19200 38400	
J1 to J16	1 2 31 32	Communication address selection (OFF : 0, ON : 1)

### ③ Input terminals

No.	Code	Function
1	VCC	12-24VDC
2	GND	0V
3	—	—
4	A(+)	RS485 A(+)
5	B(-)	RS485 B(-)

※For D□22-□T, connect the connector to input terminal.

# Intelligent Display Unit

## ① Temp./Humi. sensor module input model

### ① Expansion connector

Using for connecting units.  
Refer to ' ■ Connection of units'.

#### • DS16-RD

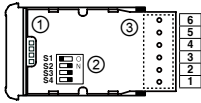

#### • DS22-RD

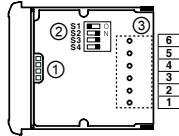

#### • DS40-RD/RDT

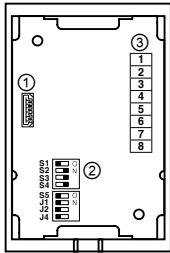

#### • DS60-RD/RDT

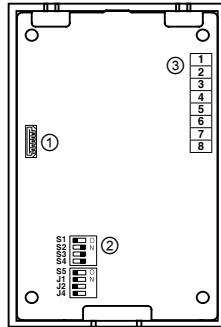

※Function set switches S5, J1, J2, J4 and input terminals no. 7, 8 are only for RS485 com. output model (DS40-RDT, DS60-RDT).

## ② Function set switch

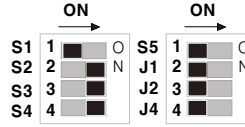

<Factory default>

No.	Switch		Function
	OFF	ON	
S1 S2	S1 OFF ON	S2 OFF ON	Displays temp./humi.
	Func.	Temp. Humi. Temp. + Humi. Temp./Humi. cross	
S3	Not used	Used	Decimal point
S4	Not used	Used	Unit-display unit
S5	9,600bps	38,400bps	Com. speed
J1 J2 J4	J1 1 2 J2 1 2 J4 1 2	J1 7 8 J2 7 8 J4 7 8	Com. address

## ③ Input terminal

No.	Code	Function	Note
1	VCC	12-24VDC	Power
2	GND	0V	
3	THD VCC	THD-RM-S VCC	Temp./Humi. sensor module
4	THD GND	THD-RM-S GND	
5	THD SDA	THD-RM-S DATA	
6	THD SCL	THD-RM-S CLOCK	
7	A(+)	RS485 A(+)	RS485 com.
8	B(-)	RS485 B(-)	

## ① Pt temp. sensor input model

### ① Expansion connector

Using for connecting units.  
Refer to ' ■ Connection of units'.

#### • DS22-RR

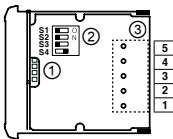

#### • DS60-RR/RRT

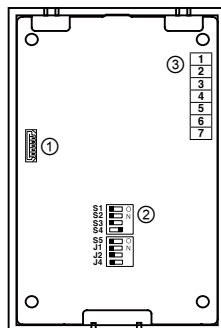

#### • DS40-RR/RRT

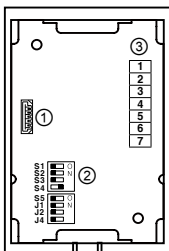

※Function set switches S5, J1, J2, J4 and input terminals no. 6, 7 are only for RS485 com. output models (DS40-RRT, DS60-RRT).

## ② Function set switch



<Factory default>

No.	Switch		Function
	OFF	ON	
S1	DpT 100Ω	JpT 100Ω	Temp. sensor
S2	°C	°F	Temp. unit
S3	10 <sup>2</sup>	10 <sup>1</sup>	Displays integer
S4	Not used	Used	Decimal point
S5	9,600bps	38,400bps	Com. speed
J1 J2 J4	J1 1 2 J2 1 2 J4 1 2	J1 7 8 J2 7 8 J4 7 8	Com. address

## ③ Input terminal

No.	Code	Function	Note
1	VCC	12-24VDC	Power
2	GND	0V	
3	A	Pt temp. sensor A	JpT 100Ω DPt 100Ω
4	B	Pt temp. sensor B	
5	B'	Pt temp. sensor B'	
6	A(+)	RS485 A(+)	RS485 com.
7	B(-)	RS485 B(-)	

(A) Photo electric sensor

(B) Fiber optic sensor

(C) Door/Area sensor

(D) Proximity sensor

(E) Pressure sensor

(F) Rotary encoder

(G) Connector/Socket

(H) Temp. controller

(I) SSR/Power controller

(J) Counter

(K) Timer

(L) Panel meter

(M) Tacho/Speed/Pulse meter

(N) Display unit

(O) Sensor controller

(P) Switching mode power supply

(Q) Stepper motor& Driver&Controller

(R) Graphic/Logic panel

(S) Field network device

(T) Software

(U) Other

# DS/DA Series

## ■ Dimensions

(unit : mm)

### ◎ DS16

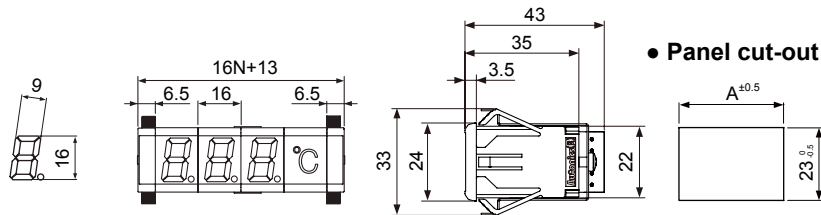

※N: Number of units  
※Panel thickness: 1.5 to 4mm

Units(N)	A(16N+11)
1	27
2	43
3	59
4	75
5	91
:	:

### ◎ DS22/DA22

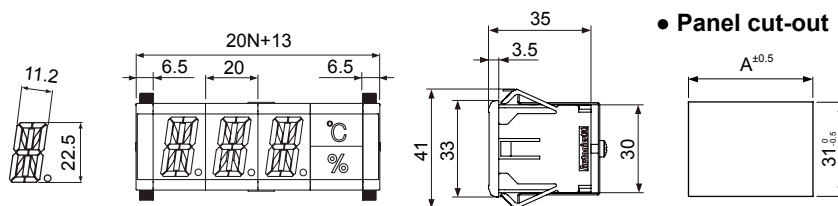

Units(N)	A(20N+11)
1	31
2	51
3	71
4	91
5	111
:	:

### ◎ DS40/DA40

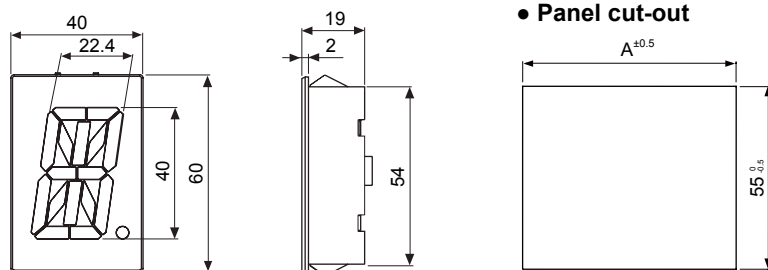

Units(N)	A(40N+2)
1	38
2	78
3	118
4	158
5	198
6	238
7	278
8	318
9	358
10	398
:	:

### ◎ DS60/DA60

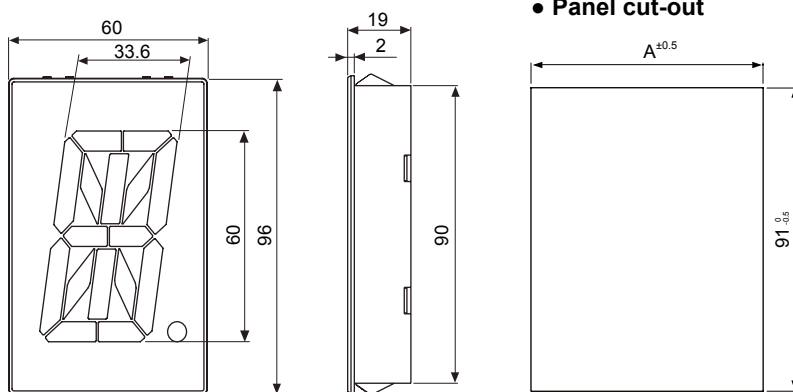

※N: Number of units  
※Panel thickness: 1.5 to 4mm

Units(N)	A(60N-3)
1	57
2	117
3	177
4	237
5	297
6	357
7	417
8	477
9	537
10	597
:	:

# Intelligent Display Unit

## ■ Dimensions

### ◎ Temp./Humi. sensor module (THD-RM-S)

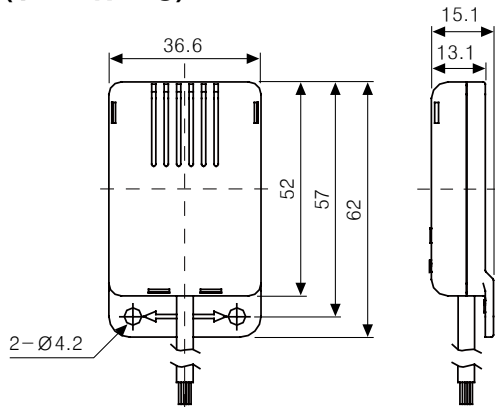

## ■ Accessories and sold separately

### ● Accessory

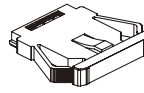

Cap

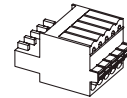

Connector for D□22-S/T

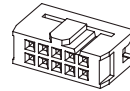

Connector for D□-P

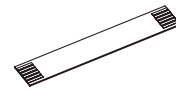

Ribbon cable (50mm)

### ● Sold separately (middle bracket)

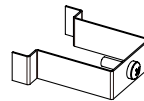

For DS16 (BK-D16R)

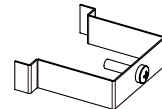

For DS22/DA22 (BK-D22R)

## ■ Unit-display unit

This unit is for displaying unit by inserting a name plate. It has only 16, 22 sizes. (sold separately)

### ● Model

Color	Red	Green
16mm	DU16-R	DU16-G
22mm	DU22-R	DU22-G

## ◎ Unit name plates

It provides unit-printed name plates as an accessory. You can select the desired unit name plate and insert this plate. (Single-stage unit name plate: 19 types, Dual-stage unit name plate: 2 types)



Single-stage unit name plate



Dual-stage unit name plate

## ◎ Unit name plate insertion

Remove the protection sheet and insert the unit name plate at between the case and the reflector.

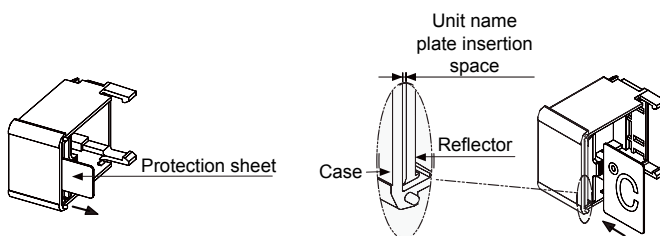

⚠ Caution: Be sure about the correct insert direction.

(A) Photo electric sensor

(B) Fiber optic sensor

(C) Door/Area sensor

(D) Proximity sensor

(E) Pressure sensor

(F) Rotary encoder

(G) Connector/Socket

(H) Temp. controller

(I) SSR/Power controller

(J) Counter

(K) Timer

(L) Panel meter

(M) Tacho/Speed/ Pulse meter

(N) Display unit

(O) Sensor controller

(P) Switching mode power supply

(Q) Stepper motor& Driver&Controller

(R) Graphic/Logic panel

(S) Field network device

(T) Software

(U) Other



# DS/DA Series

## Input DATA chart [Serial, Parallel, RS485 input model]

When selecting 5Bit data input for the serial input model, or 4Bit data input for the parallel input model, it displays only shaded part (0 to 9, A to F). If there is no input data after supplying the power, the basic unit differently displays by each input method; serial input model displays 'S', parallel input model displays 'P', and RS485 communication input model displays 'T'.

DS Series (7 segment)								DS Series(16 segment)								DU Series (unit)		Hi 2Bit / Low 4Bit			
D5	D4	D5	D4	D5	D4	D5	D4	D5	D4	D5	D4	D5	D4	D5	D4	D5	D4	D3	D2	D1	D0
L	L	L	H	H	L	H	H	L	L	L	H	H	L	H	H	X	X				
0	0	G	W	]	0	0	G	W	]	No unit	L	L	L	L							
1	H	X	8	1	H	X	[	Upper-Lower OFF	L	L	L	H									
2	I	Y	8	2	I	Y	+	Upper-Lower ON	L	L	H	L									
3	J	Z	8	3	J	Z	:	Upper ON	L	L	H	H									
4	K	-1	8	4	K	-1	;	Lower ON	L	H	L	L									
5	L	(	8	5	L	(	<	Upper-Lower flashes	L	H	L	H									
6	M	)	H	6	M	)	>	Upper flashes	L	H	H	L									
7	N	'	l	7	N	'		Lower flashes	L	H	H	H									
8	O	"	J	8	O	"	!	※1	H	L	L	L									
9	P	^	K	9	P	^	@		H	L	L	H									
A	Q	.	K	A	Q	.	#		H	L	H	L									
b	R	/	N	B	R	/	\$		H	L	H	H									
c	S	?	O	C	S	?	%		H	H	L	L									
d	T	-	T	D	T	-	&		H	H	L	H									
E	U	_	X	E	U	_	*		H	H	H	L									
F	V	=	Blank	F	V	=	Blank		H	H	H	H									

※1: If this data is not for the unit-display unit, it maintains former state.

※The unit-display unit does not use the upper bit over D4. (Don't care: X)

※Unit-display unit function

Upper/Lower selection, ON/Flash function

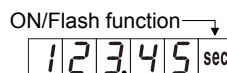
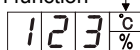

※It is only available to use the unit-display unit with serial 5bit, parallel 4/6bit Dynamic 1 input when connecting the unit display unit and turning ON it. (Do not input data to the unit-display unit.)

※To display two data using zero blanking function

① Using the unit-display unit: If sending unit data signal after no.1 data(00123), it applies zero blanking function when displaying no.2 data (04567).

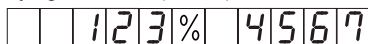

② Not using the unit-display unit: If sending no-unit data (HXXXLLLL) after no.1 data(00123), it applies zero blanking function to display no.2 data. In this case, transmitted data should be added one to the display digits. (no-unit data is added)



When do not using unit-display unit, no-unit data is used for data division. If it does not send no-unit data(HXXXLLLL), it displays no.1 data (00123) and no.2 data (04567) as one data.

Zero-blanking function is applied to no.1 data only.

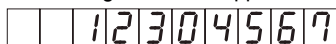

※Do not transfer unit data to basic/expansion unit. Unit bit(D7) of unit data is only for unit. If transferring unit data to basic/expansion unit, unit bit (D7) displays the ignored data value. In this case, Zero blanking does not operate normally.

## DATA input method [Serial, Parallel, RS485 input model]

### Serial input model

#### 5Bit Serial input (ex: displays 12.8°C)

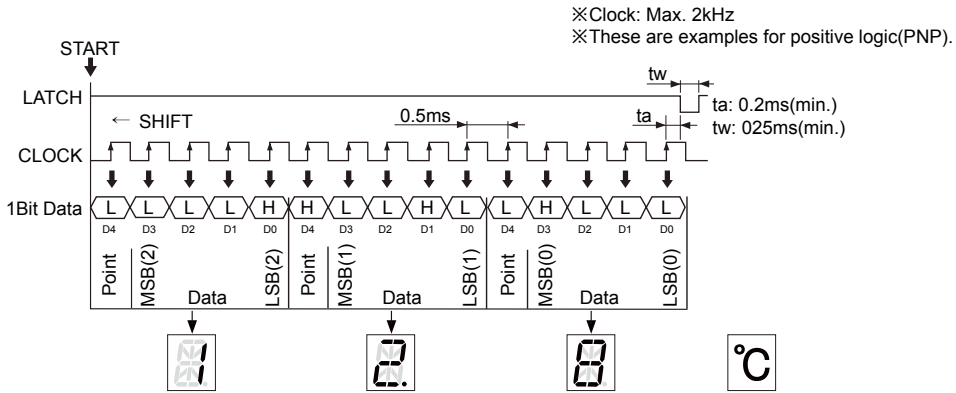

⚠ Caution: The unit-display unit is available only for turning ON. Do not input data to the unit-display unit.

#### 8Bit Serial input (ex: displays 25°C)

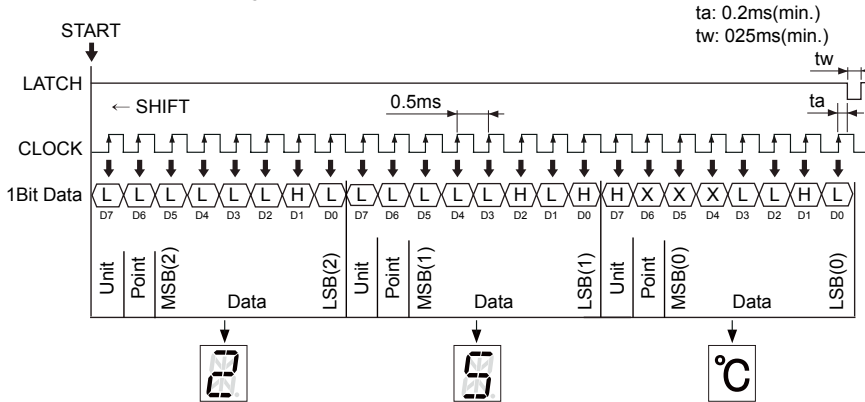

### Parallel input model

Example of unit organization by data input

Dynamic Parallel 1	4Bit	Connectable 1 basic unit and 5 expansion units(6Digit) Ex) 10digit organization: (1 basic unit + 5 expansion units)+(1 basic unit + 3 expansion units)
	6Bit	Connectable 1 basic unit and 3 expansion units(4Digit) Ex) 10digit organization: (1 basic unit + 3 expansion units)×2+(1 basic unit + 1 expansion units)
Dynamic Parallel 2	6Bit	Connectable 1 basic unit and 23 expansion units(24Digit) Ex) 30digit organization: (1 basic unit + 23 expansion units)+(1 basic unit + 5 expansion units)

#### 4Bit Dynamic Parallel 1 transmission (ex: displays ACE007.)

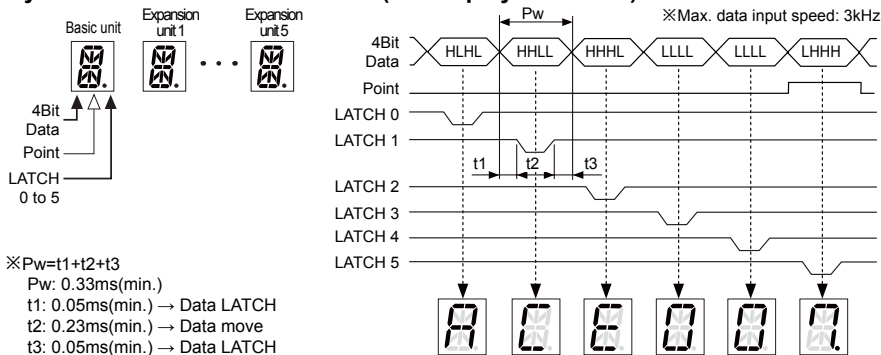

- (A) Photo electric sensor
- (B) Fiber optic sensor
- (C) Door/Area sensor
- (D) Proximity sensor
- (E) Pressure sensor
- (F) Rotary encoder
- (G) Connector/Socket
- (H) Temp. controller
- (I) SSR/ Power controller
- (J) Counter
- (K) Timer
- (L) Panel meter
- (M) Tacho/ Speed/ Pulse meter
- (N) Display unit
- (O) Sensor controller
- (P) Switching mode power supply
- (Q) Stepper motor& Driver&Controller
- (R) Graphic/ Logic panel
- (S) Field network device
- (T) Software
- (U) Other

# DS/DA Series

## • 4Bit Dynamic Parallel 1 transmission (ex: displays 012345.6789)

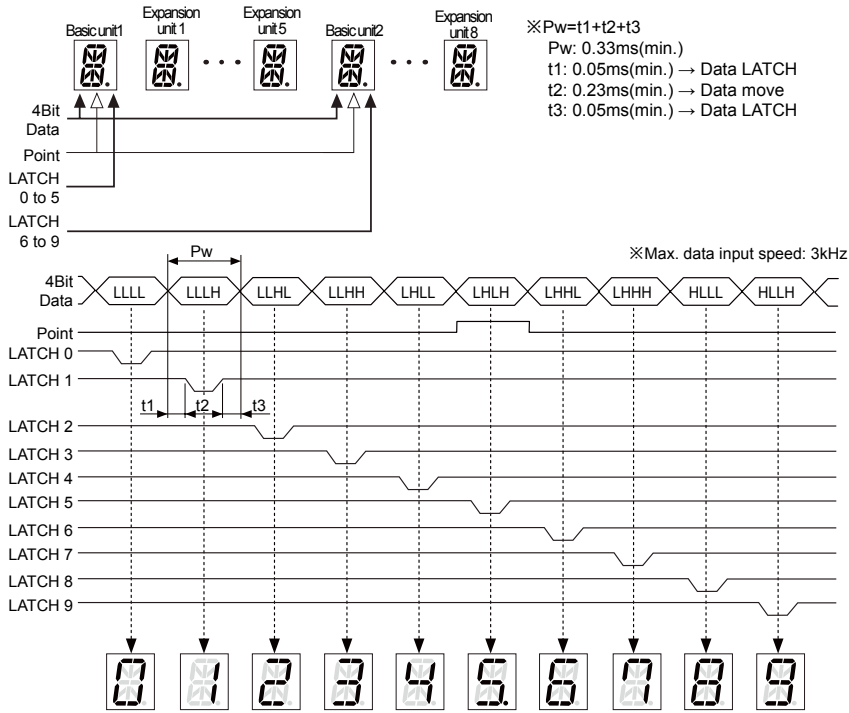

## • 6Bit Dynamic Parallel 1 transmission (ex: displays 50.80kg)

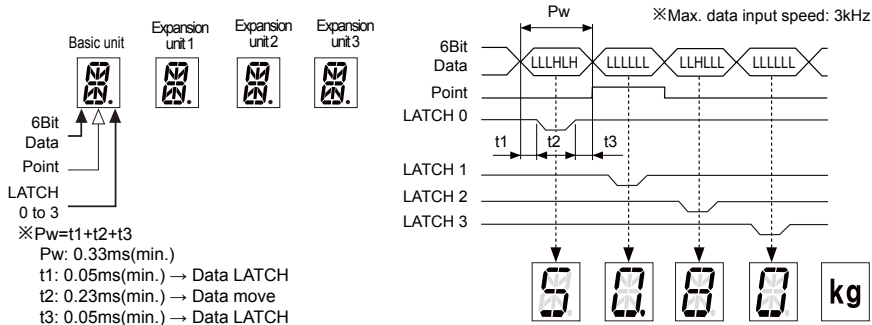

⚠Caution: The unit-display unit is available only for turning ON. Do not input data to the unit-display unit.

※General parallel input is only for basic unit (Dynamic Parallel 1).

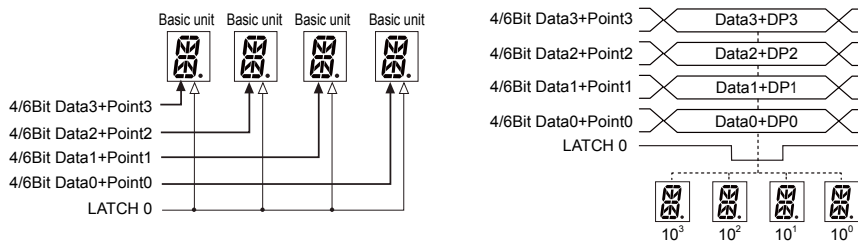

## • 6Bit Dynamic Parallel 1 transmission (ex: displays-AUTONICS-)

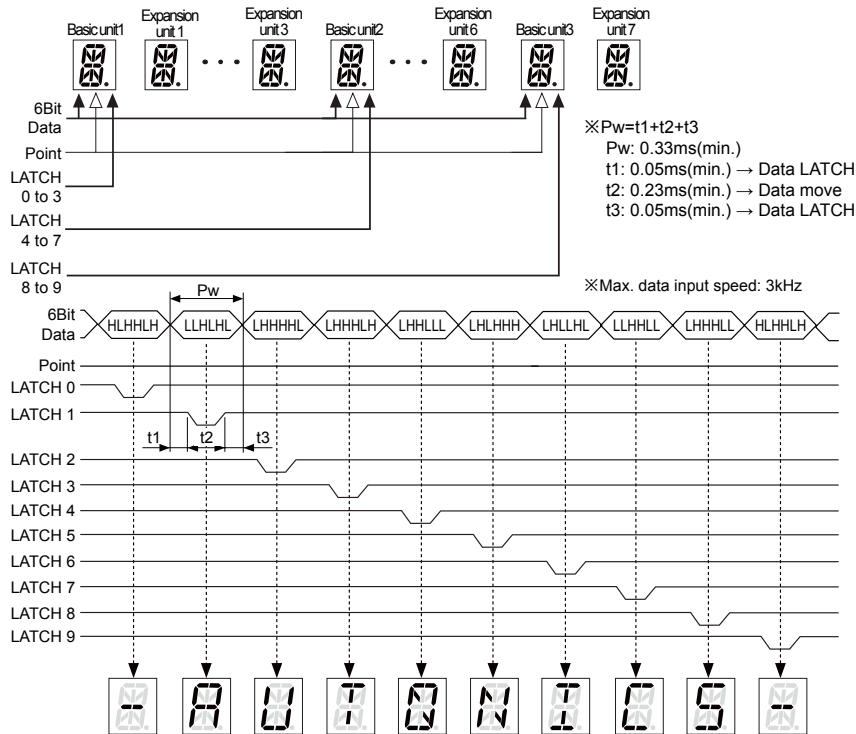

## • 6Bit Dynamic Parallel 2 transmission (ex: displays AB.C... W°F)

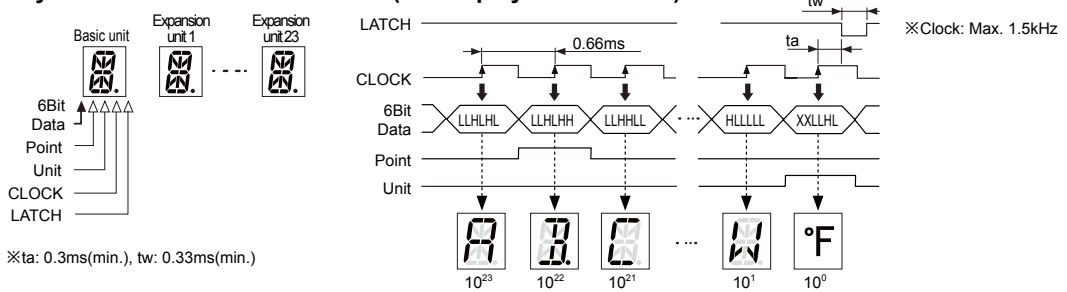

## © RS485 communication input model

### • Ex: Displays 10H38M(10 hour 38 min.)

Communication address: 1, Communication speed: 9600bps, Data Bit: 8Bit, Start/Stop Bit: 1Bit, Parity Bit: None

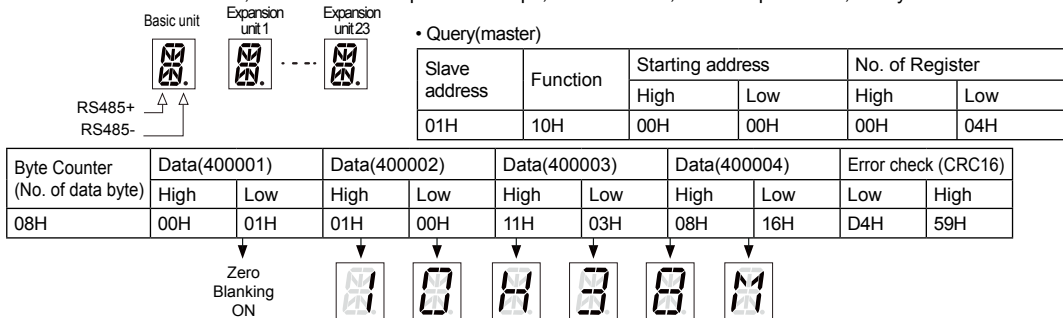

### • Response(slave)

Slave Address	Function	Starting Address		No. of Register		Error Check(CRC16)	
		High	Low	High	Low	Low	High
01H	10H	00H	00H	00H	04H	C1H	CAH

- (A) Photo electric sensor
- (B) Fiber optic sensor
- (C) Door/Area sensor
- (D) Proximity sensor
- (E) Pressure sensor
- (F) Rotary encoder
- (G) Connector/ Socket
- (H) Temp. controller
- (I) SSR/ Power controller
- (J) Counter
- (K) Timer
- (L) Panel meter
- (M) Tacho/ Speed/ Pulse meter
- (N) Display unit
- (O) Sensor controller
- (P) Switching mode power supply
- (Q) Stepper motor& Driver&Controller
- (R) Graphic/ Logic panel
- (S) Field network device
- (T) Software
- (U) Other

# DS/DA Series

## ■ Examples of display [Temp./Humi. sensor module, Pt temp. input model]

### ◎ Temp./Humi. sensor module input model

S1 S2 S3 S4 : Function set switch

1) Temperature display (ex: displays -19.9°C)



2) Humidity display (ex: displays 50%)



3) Temperature+Humidity display (ex: displays 6.0°C and 80.0%)



4) Temperature, Humidity display in turn (ex: displays -7.5°C and 45.8% in turn)

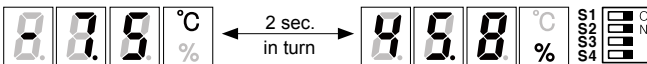

### ◎ Pt temp. sensor input model

1) Temperature(°C) display  
(displays DPt100Ω, 400.0°C)



2) Temperature(°F) display  
(JPt100Ω, 75.2°F)



※Temp./Humi. sensor module, Pt temp. sensor input model are applied Zero Blanking function automatically.

## ■ RS485 communication specifications

※Only for RS485 communicatio input/output model.

Item	Specifications	
	RS485 com. input model(D□□□T)	RS485 com. output model(DS□□RDT/RRT)
Communication protocol	Modbus RTU with 16bit CRC	
Connection type	RS485	
Application standards	EIA RS485 standards	
Max. connections	31 units(address: 01 to 32)	8 units(address: 01 to 08)
Communication type	2-wire half duplex(Half Duplex)	
Communication distance	Max. 800m	
Communication speed	4800/9600 /19200/38400bps	9600/38400bps
Communication response time	5ms, 20ms	5ms(fixed)
Start Bit	1Bit(fixed)	
Data Bit	8Bit(fixed)	
Parity Bit	None(fixed)	
Stop Bit	1Bit(fixed)	
Protocol	Modbus RTU	

## ■ Integrated device management program (DAQMaster)

It is only for the RS485 communication input model DAQMaster is able to display I/O source value, unit, and user setting value. For more information, please refer to the DAQMater user manual.

Visit our website ([www.autonics.com](http://www.autonics.com)) to download DAQMaster program.

Item	Minimum requirements
System	IBM PC compatible computer with Intel Pentium III or above
Operating system	Microsoft Windows 98/NT/XP/Vista/7
Memory	256MB or more
Hard disk	More than 1GB of free hard disk space
VGA	1024×768 or higher resolution display
Others	RS-232 serial port(9-pin), USB port

## ■ Communication setting

### ◎ Application of system organization

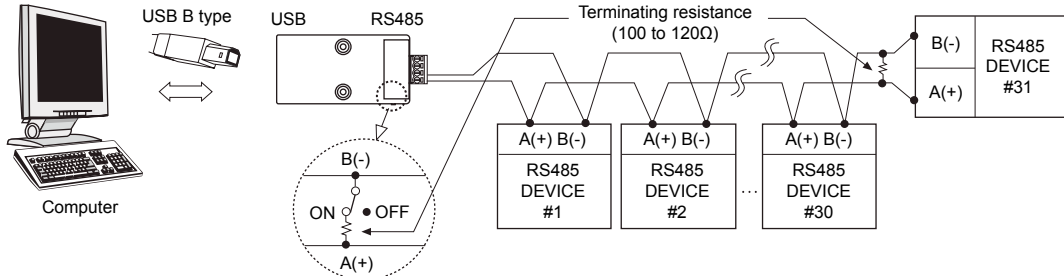

※It is recommended to use Autonics communication converter; SCM-US48I (USB to RS485 converter, sold separately), SCM-38I (RS232C to RS485 converter, sold separately). Please use twisted pair wire for RS485 communication.

### ◎ Modbus Address Mapping

#### ● Data format

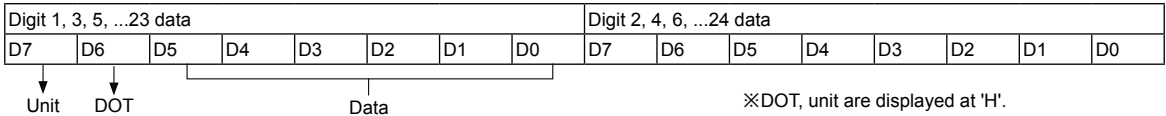

#### ● Product information

No(Address)	Function	R/W	Parameter	Description	Factory default		Note		
					D□□□□□	DS□-RDT/RRT	D□□□□□	DS□-RDT/RRT	
300001 to 300100	04	R	Reserved						
300101(0064)	04	R	—	Product number H	—		—		
300102(0065)	04	R	—	Product number L	—		—		
300103(0066)	04	R	—	Hardware version	—		—		
300104(0067)	04	R	—	Software version	—		—		
300105(0068)	04	R	—	Model name 1	'DS'		DS(A)xx-xT	DSxx-RDT DSxx-RRT	
300106(0069)	04	R	—	Model name 2	'A'	'xx'			
300107(006A)	04	R	—	Model name 3	'x'	'-R'			
300108(006B)	04	R	—	Model name 4	'x-'	'DT' or 'RT'			
300109(006C)	04	R	—	Model name 5	'xT'	0			
300110(006D) to 300114(0071)	04	R	—	Model name 6 to 10	0		—		

#### ● Monitoring data

※Supports only temp./humid. module input+RS485 com. output(DS□-RDT), Pt temp. input+RS485 com. output(DS□-RRT) models.

No(Address)	Function	R/W	Parameter	Description		Factory default	Note
				DS□-RDT	DS□-RRT		
301001(03E8)	04	R	—	Temp.(-199 to 600)	°C Temp.(-500 to 4000)	—	Data of ×10
301002(03E9)	04	R	—	Humi.(0 to 999)	°F Temp.(-580 to 7520)	—	Data of ×10
301003 to 301100	04	R	—	Reserved			

#### ● Display data

※Supports only RS485 com. input (D□□□□□)model.

No(Address)	Function	R/W	Parameter	Parameter name	Description	Set range	Factory default	
400001(0000)	03/06/16	R/W	—	Zero Blanking	Zero Blanking ON/OFF set	0 : OFF, 1 : ON	0	
400002(0001)	03/06/16	R/W	—	Digit 1, 2	1, 2 display data	Refer to Input data chart	0	
400003(0002)	03/06/16	R/W	—	Digit 3, 4	3, 4 display data		0	
400004(0003)	03/06/16	R/W	—	Digit 5, 6	5, 6 display data		0	
400005(0004)	03/06/16	R/W	—	Digit 7, 8	7, 8 display data		0	
400006(0005)	03/06/16	R/W	—	Digit 9, 10	9, 10 display data		0	
400007(0006)	03/06/16	R/W	—	Digit 11, 12	11, 12 display data		0	
400008(0007)	03/06/16	R/W	—	Digit 13, 14	13, 14 display data		0	
400009(0008)	03/06/16	R/W	—	Digit 15, 16	15, 16 display data		0	
400010(0009)	03/06/16	R/W	—	Digit 17, 18	17, 18 display data		0	
400011(000A)	03/06/16	R/W	—	Digit 19, 20	19, 20 display data		0	
400012(000B)	03/06/16	R/W	—	Digit 21, 22	21, 22 display data		0	
400013(000C)	03/06/16	R/W	—	Digit 23, 24	23, 24 display data		0	
400014 to 4000050	03/06/16	R/W	—	Reserved				0

- (A) Photo electric sensor
- (B) Fiber optic sensor
- (C) Door/Area sensor
- (D) Proximity sensor
- (E) Pressure sensor
- (F) Rotary encoder
- (G) Connector/Socket
- (H) Temp. controller
- (I) SSR/ Power controller
- (J) Counter
- (K) Timer
- (L) Panel meter
- (M) Tacho/ Speed/ Pulse meter
- (N) Display unit
- (O) Sensor controller
- (P) Switching mode power supply
- (Q) Stepper motor& Driver&Controller
- (R) Graphic/ Logic panel
- (S) Field network device
- (T) Software
- (U) Other

# DS/DA Series

## ■ Definition of communication command and block

- Displays format of Query and Response.

1) Read Coil Status(Func 01H), Read Input Status(Func 02H)

### ● Query(Server)

Address	Function	Start address		No. of data		CRC-16	
		HI	LO	HI	LO	LO	HI
1Byte	1Byte	1Byte	1Byte	1Byte	1Byte	1Byte	1Byte

### ● Response(Slave)

Address	Function	No. of data byte	Data		Data		CRC-16	
			HI	LO	HI	LO	LO	HI
1Byte	1Byte	1Byte	1Byte	1Byte	1Byte	1Byte	1Byte	

2) Read Holding Registers(Func 03H), Read Input Registers(Func 04H)

### ● Query(Server)

Address	Function	Start address		No. of data		CRC-16	
		HI	LO	HI	LO	LO	HI
1Byte	1Byte	1Byte	1Byte	1Byte	1Byte	1Byte	1Byte

### ● Response(Slave)

Address	Function	No. of data byte	Data		Data		Data		CRC-16	
			HI	LO	HI	LO	HI	LO	LO	HI
1Byte	1Byte	1Byte	1Byte	1Byte	1Byte	1Byte	1Byte	1Byte	1Byte	

3) Force Single Coil(Func 05H)

### ● Query(Server)

Address	Function	Coil address		Force Data		CRC-16	
		HI	LO	HI	LO	LO	HI
1Byte	1Byte	1Byte	1Byte	1Byte	1Byte	1Byte	1Byte

### ● Response(Slave)

Address	Function	Coil address		Force Data		CRC-16	
		HI	LO	HI	LO	LO	HI
1Byte	1Byte	1Byte	1Byte	1Byte	1Byte	1Byte	1Byte

4) Preset Single Register(Func 06H)

### ● Query(Server)

Address	Function	Register address		Preset Data		CRC-16	
		HI	LO	HI	LO	LO	HI
1Byte	1Byte	1Byte	1Byte	1Byte	1Byte	1Byte	1Byte

### ● Response(Slave)

Address	Function	Register address		Preset Data		CRC-16	
		HI	LO	HI	LO	LO	HI
1Byte	1Byte	1Byte	1Byte	1Byte	1Byte	1Byte	1Byte

5) Preset Multiple Registers(Func 10H)

### ● Query(Server)

Address	Function	Start address		No. of Reg		No. of data byte	Data		Data		CRC-16	
		HI	LO	HI	LO		HI	LO	LO	HI		
1Byte	1Byte	1Byte	1Byte	1Byte	1Byte	1Byte	1Byte	1Byte	1Byte	1Byte	1Byte	

### ● Response(Slave)

Address	Function	Start address		Register Data		CRC-16	
		HI	LO	HI	LO	LO	HI
1Byte	1Byte	1Byte	1Byte	1Byte	1Byte	1Byte	1Byte

## ■ Communication output

### ◎ Example of communication: Displays "DA16" 4 digit

#### ● Communication setting

Communication address: 1 (J1-ON, J2-OFF, J3-OFF, J4-OFF, J8-OFF, J16-OFF)

Communication speed: 9600 bps (S2-ON, S3-OFF)

Data Bit: 8Bit(fixed)

Start/Stop Bit: 1Bit(fixed)

Parity Bit: None(fixed)

#### ● Query

Address	Function	Start address		No. of data		No. of byte	Data (4000001)		Data (4000002)		Data (4000003)		Error Check (CRC16)	
		HI	LO	HI	LO		LO	HI	LO	HI	LO	HI		
01	10	00	00	00	03	06	00	01	0D	0A	01	06	78	7C

#### ● Response

Address	Function	Start address		No. of data		CRC16	
		HI	LO	HI	LO	LO	HI
01	10	00	00	00	03	80	08

## ■ PLC example program

### ◎ Parallel Dynamic1(4bit) input method

① Display Unit DS/DA22-RP(1EA), Display Unit DS/DA22-RE(1EA)

② Data input method: Parallel Dynamic 1(4Bit)

③ Display result: "26°C" 3 digit display(flashes °C)

④ PLC: Autonics LP Series

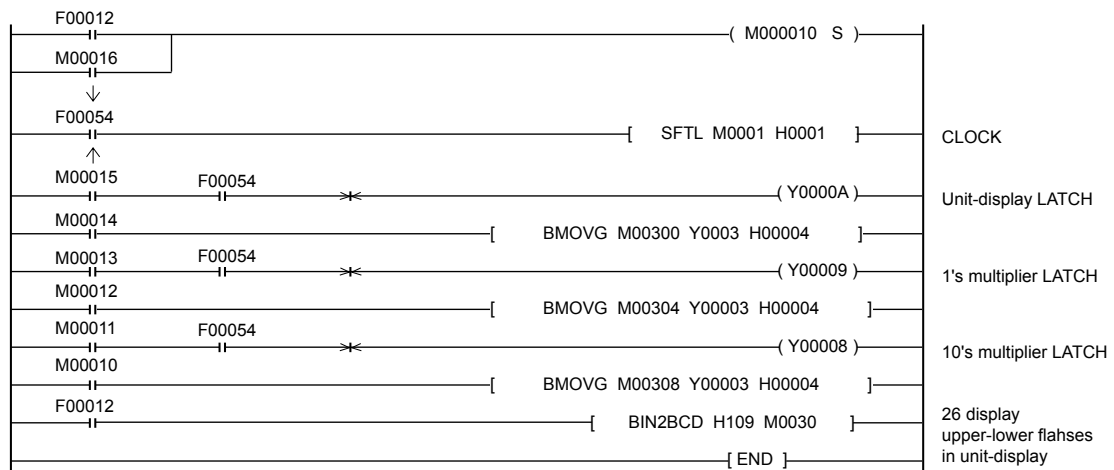

(A)	Photo electric sensor
(B)	Fiber optic sensor
(C)	Door/Area sensor
(D)	Proximity sensor
(E)	Pressure sensor
(F)	Rotary encoder
(G)	Connector/Socket
(H)	Temp. controller
(I)	SSR/ Power controller
(J)	Counter
(K)	Timer
(L)	Panel meter
(M)	Tacho/ Speed/ Pulse meter
(N)	Display unit
(O)	Sensor controller
(P)	Switching mode power supply
(Q)	Stepper motor& Driver&Controller
(R)	Graphic/ Logic panel
(S)	Field network device
(T)	Software
(U)	Other



# DS/DA Series

## ◎ Serial(5bit) input method

- ① Display Unit DS/DA22-RP(1EA) Display Unit DS/DA22-RE(1EA)
- ② Data input method: Serial(5Bit)
- ③ Display result: "26°C" Display(flashes °C)
- ④ PLC: Autonics LP Series

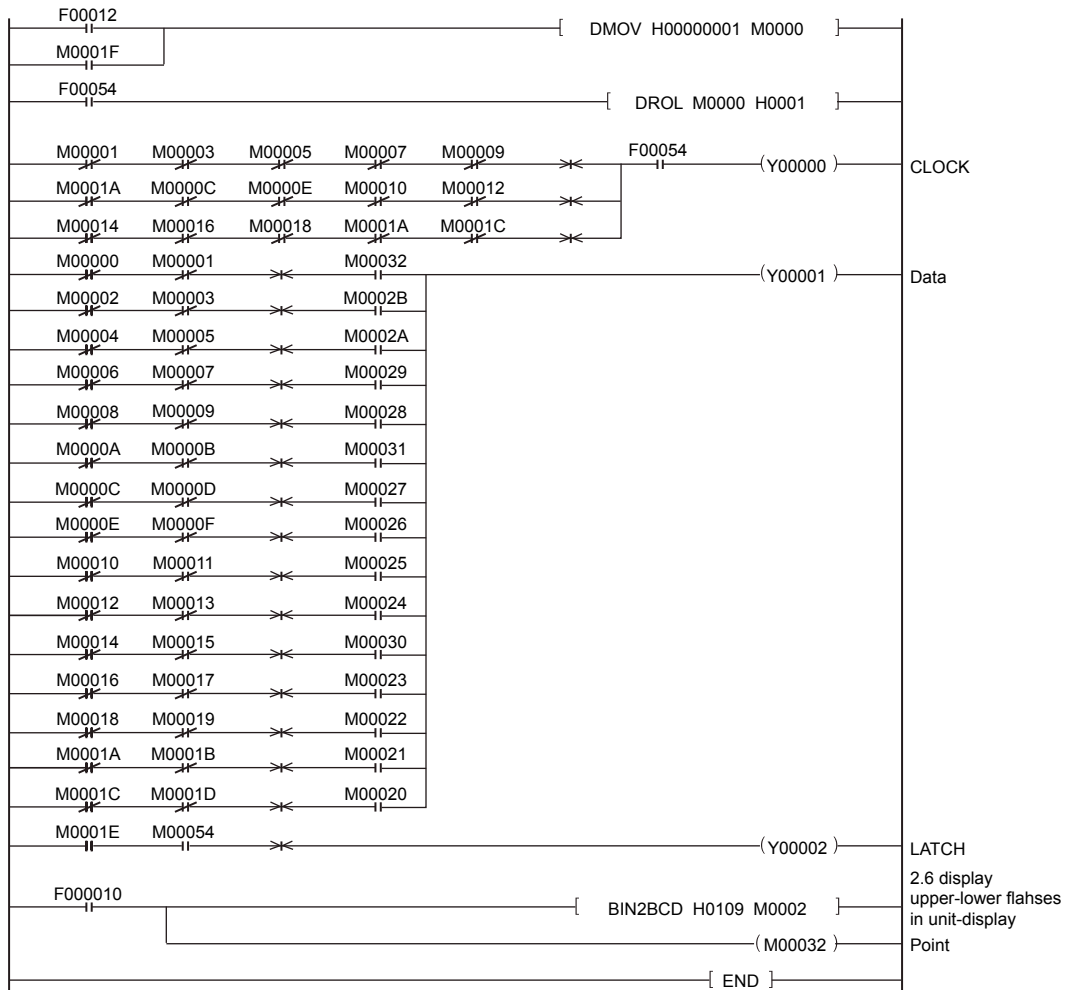

## ■ Caution for using

1. This unit must be mounted on the panel.
2. This is non-insulated product. Use insulated power for power supply.
3. For using temp./humi. sensor module input, Pt temp. sensor input model, you must wire 3-wire. To extend the wire, the thickness and length of 3 wires should be same. If the resistance are different, temperature error occurs.
4. For temp./humi. sensor module input, Pt temp. sensor input, if input value is out of the range, each display unit displays Error message. When it is under min. input value, a unit displays 'L'. When it is over max. input value, a unit displays 'H'.
5. For temp./humi. sensor module input, Pt temp. sensor input model, if temp./humi. sensor module or Pt temp. sensor is not connected, it displays 'oP (using 2 units)' or 'oPn (using 3 units)'.
6. Input signal line
  - ① Shorten the cable distance between the external device and this product.
  - ② Use shield cable when input wiring is long.
  - ③ Wire the input signal line separately from the power line.
7. Dielectric or insulation resistance test when this unit is installed in the control panel.
  - ① Separate the unit from the control panel.
  - ② Short circuit all terminals of the unit.
8. Do not use this unit at below places.
  - ① Place where there are severe vibration or impact.
  - ② Place where strong alkalis or acids are used.
  - ③ Place where there are direct ray of the sun
  - ④ Place where strong magnetic field or electric noise are generated
9. Installation environment
  - ① It shall be used indoor
  - ② Altitude Max. 2,000m
  - ③ Pollution Degree 2
  - ④ Installation Category I